

HEAD & CAP TIE ROD EXTENDED

Peninsular
Mounting Style: **MH 12**

Heavy Duty Steel Air Cylinder

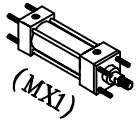

KM (SHORT MALE)
KF (SHORT FEMALE)
KD (FULL MALE)
KI (INTERMEDIATE MALE)
KA (LONG MALE)

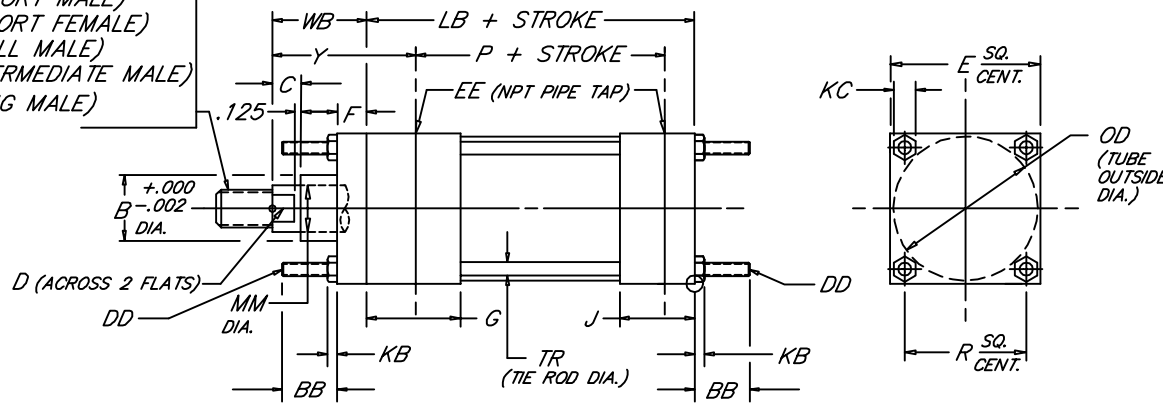
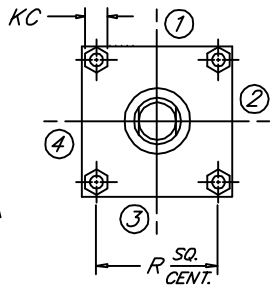

1.19

BORE	ROD					ROD THREAD X LENGTH														NPT				
	MM	KM & KF	KD	KI	KA	B	BB	C	D	DD	E	EE	F	G	J	KB	KC	LB	OD	P	R	TR	WB	Y
1.500	.625	7/16"-20 x .750	5/8"-18 x .750	1/2"-20 x .750	1/2"-20 x 1.125	1.124	1.000	.375	.500	1/4"-28	2.000	3/8	.375	1.500	1.000	.218	.438	3.625	1.750	2.335	1.428	.250	1.000	1.875
	1.000	3/4"-16 x 1.125	1"-14 x 1.125	7/8"-14 x 1.125	7/8"-14 x 1.875	1.499	1.000	.500	.875														1.375	2.250
2.000	.625	7/16"-20 x .750	5/8"-18 x .750	1/2"-20 x .750	1/2"-20 x 1.125	1.124	1.125	.375	.500	5/16"-24	2.500	3/8	.375	1.500	1.000	.250	.500	3.625	2.250	2.335	1.838	.312	1.000	1.875
	1.000	3/4"-16 x 1.125	1"-14 x 1.125	7/8"-14 x 1.125	7/8"-14 x 1.875	1.499	1.125	.500	.875														1.375	2.250
2.500	.625	7/16"-20 x .750	5/8"-18 x .750	1/2"-20 x .750	1/2"-20 x 1.125	1.124	1.125	.375	.500	5/16"-24	3.000	3/8	.375	1.500	1.000	.250	.500	3.750	2.750	2.460	2.192	.312	1.000	1.875
	1.000	3/4"-16 x 1.125	1"-14 x 1.125	7/8"-14 x 1.125	7/8"-14 x 1.875	1.499	1.125	.500	.875														1.375	2.250
3.250	1.375	1"-14 x 1.625	1 3/8"-12 x 1.625	1 1/4"-12 x 1.625	1 1/4"-12 x 2.500	1.999	1.375	.625	1.125	3/8"-24	3.750	1/2	.625	1.750	1.250	.328	.562	4.250	3.500	2.750	2.758	.375	1.625	2.625
	1.750	1 1/4"-12 x 2.000	1 3/4"-12 x 2.000	1 1/2"-12 x 2.000	1 1/2"-12 x 3.000	2.374	1.375	.750	1.500														1.875	2.875
4.000	2.000	1 1/2"-12 x 2.250	2"-12 x 2.250	1 3/4"-12 x 2.250	1 3/4"-12 x 3.500	2.624	1.375	.875	1.688	3/8"-24	4.500	1/2	.625	1.750	1.250	.328	.562	4.250	4.250	2.750	3.323	.375	2.000	3.000
	2.500	1 7/8"-12 x 3.000	2 1/2"-12 x 3.000	2 1/4"-12 x 3.000	2 1/4"-12 x 4.500	3.124	1.000	1.000	2.062														2.250	3.250
5.000	1.000	3/4"-16 x 1.125	1"-14 x 1.125	7/8"-14 x 1.125	7/8"-14 x 1.875	1.499		.500	.875														1.375	2.375
	1.375	1"-14 x 1.625	1 3/8"-12 x 1.625	1 1/4"-12 x 1.625	1 1/4"-12 x 2.500	1.999		.625	1.125														1.625	2.625
6.000	1.750	1 1/4"-12 x 2.000	1 3/4"-12 x 2.000	1 1/2"-12 x 2.000	1 1/2"-12 x 3.000	2.374	1.812	.875	1.688	1/2"-20	5.500	1/2	.625	1.750	1.250	.438	.750	4.500	5.250	3.000	4.101	.500	1.875	2.875
	2.000	1 1/2"-12 x 2.250	2"-12 x 2.250	1 3/4"-12 x 2.250	1 3/4"-12 x 3.500	2.624	1.812	1.000	2.062														2.250	3.250
6.000	2.500	1 7/8"-12 x 3.000	2 1/2"-12 x 3.000	2 1/4"-12 x 3.000	2 1/4"-12 x 4.500	3.124	1.812	1.000	2.062	1/2"-20	6.500	3/4	.750	2.000	1.500	.438	.750	5.000	6.250	3.250	4.879	.500	2.250	3.375
	3.000	2 1/4"-12 x 3.500	3"-12 x 3.500	2 3/4"-12 x 3.500	2 3/4"-12 x 5.500	3.749	1.000	1.000	2.625														2.250	3.250
6.000	3.500	2 1/2"-12 x 3.500	3 1/2"-12 x 3.500	3 1/4"-12 x 3.500	3 1/4"-12 x 6.500	4.249	1.000	1.000	3.000														2.250	3.375
	4.000	3"-12 x 4.000	4"-12 x 4.000	3 3/4"-12 x 4.000	3 3/4"-12 x 7.500	4.749	1.000	1.000	3.375														2.250	3.375

NFPA DESIGN

FILE: MH12S2.dwg REV: 09-25-06